



OPERATING MANUAL

Table of contents

1.	Preface	1
2.	Meaning of symbols used	2
3.	General information	3
3.1.	Current version of the operating manual.....	3
3.2.	EC conformity.....	3
3.3.	Assembly, acceptance and recurrent testing	3
3.4.	Intended use	4
3.5.	Unintended use	4
3.6.	Lifting capacity data	5
3.7.	Data	5
3.8.	Product liability / information obligation.....	5
3.9.	Operating personnel	5
3.9.1.	Operator requirements	5
3.9.2.	Crane driver's license.....	6
4.	Safety advice and hazards	7
4.1.	Personal protective equipment.....	7
4.2.	Information and prohibition symbols on the crane	7
4.3.	Hazards.....	8
4.3.1.	Electrical overhead lines.....	8
4.3.2.	Wind effects and thunderstorms	9
4.3.3.	Risk of falling.....	10
4.3.4.	Burning risk.....	10
5.	Assembly of the crane	11
5.1.	Collapsible crane (Z crane)	11
5.2.	Open crane (L crane)	12
6.	Safety devices	13
6.1.	Inclination monitoring.....	14
6.1.1.	Inclination sensor (B2, B3).....	14
6.1.2.	Functional principle of the stability monitoring	15
6.2.	Overload protection	15
6.2.1.	Towerlight.....	16
6.2.2.	Pressure sensor	16
6.3.	Support and height monitoring.....	16
7.	Safety guidelines.....	17
7.1.	Safety guidelines before each start-up of the crane	17

7.1.1.	Defects to be checked before every crane start-up	17
7.1.2.	Suitability and ability of the crane operator to operate the crane	17
7.1.3.	Work preparation	18
7.1.4.	Working environment	18
7.1.5.	Vehicle surface and stability	18
7.1.6.	Supporting the vehicle.....	19
7.2.	Safety guidelines during crane operation	20
7.2.1.	Defects to be checked during crane operation	20
7.2.2.	Moving the crane and working with loads	20
7.2.3.	Personal protection and the protection of bystanders	21
7.3.	Safety guidelines according to crane operation	22
8.	Controlling the crane	23
8.1.	Cross lever control	24
8.1.1.	Design: narrow support, controlled hydraulically	25
8.1.2.	Design: broad support, controlled hydraulically	27
8.1.3.	Design: narrow or broad support, controlled electrically	29
8.2.	Cross lever control	31
8.2.1.	Design: narrow support, controlled hydraulically	32
8.2.2.	Design: broad support, controlled hydraulically	34
8.2.3.	Design: support controlled electrically.....	36
8.3.	Hydraulic pilot control.....	38
8.3.1.	Design	39
8.4.	Electrical pilot control	41
8.4.1.	Design	41
9.	Crane operation	44
9.1.	Preparing crane operation	44
9.2.	Putting the crane into operation.....	44
9.2.1.	Starting up at low temperatures	44
9.2.2.	When disassembling the crane, bring it into the working position (Z-crane)	45
9.3.	Crane working position	46
9.3.1.	Working range	46
9.4.	Working with loads	47
9.4.1.	Load limits	47
9.4.2.	Raise and move load.....	47
9.4.3.	Interrupt loading/unloading activity	48
9.5.	Stop crane operation.....	48
9.5.1.	Collapsing the crane, bringing the crane into the transport position (Z-crane).....	48



10. Accessories.....	50
10.1. Load handling equipment	50
10.2. High level/high seat.....	50
10.3. p+ System	51
10.4. Electrically heated seat covers	51
11. Service and maintenance	52
12. Warranty.....	53
13. Contact information	54

1. Preface

We would like to warmly welcome you to the large community of PENZ crane owners and wish you much enjoyment with your PENZ crane. This instruction book informs you about the operation and maintenance of your PENZ crane. Safety instructions are also given to protect your health and the health of people in the vicinity. In order to avoid errors when using your product as well as conflicts with the law, please observe the following information.

- The operating manual is part of the device
- Always keep the operating manual on the device!
- Clean the device regularly! Dirt increases wear on the device.
- Contamination from oil and grease increases the risk of accidents
- All prohibitions and advice in this operating manual are to be observed!
- Read the following instructions carefully!
- Observe the maintenance regulations as well as the guidelines of ÖNORM M 9601!
- Consider the test regulations as well as the specifications of ÖNORM M 9602!
- Observe the guidelines for communication during operation according to ÖNORM M 9624!
- Comply with the legal requirements of the Employee Protection Act (ASchG), the Work Equipment Ordinance (AM-VO) and the Workers' Protection Ordinance (AAV)!
- Observe the regulations of the Professional Expertise Certificate Ordinance (BGBl. II No. 13/2017) and the Workplace Ordinance (BGBl. II No. 368/1998)!

PENZ crane GmbH is characterised by the constant further development of the technology and therefore uses only the latest and most advanced technology on the device.

Finally, we would like to point out that failure to observe the maintenance instructions, unauthorised repairs, adjustment of the pressure settings (removal of the seal), as well as electrical settings and alteration of the crane by extensions or alterations will void the warranty. Furthermore, we shall not be liable for accidents caused by negligent or improper use of the crane, nor for accidents which could have been prevented by deactivating the existing safety devices ex works.

Duplication (also in extracts) is only allowed with the written permission from:

© Penz crane GmbH • Bundesstrasse 8 • 8753 Aichdorf / Fohnsdorf • Austria

The original crane from Austria

2. Meaning of symbols used



Comments with this symbol serve as advice.
Heeding this advice is strongly recommended.



Comments with this symbol must be strictly observed.
Non-observance leads to serious consequences.



Current contents are available on the home page or as download.
<- Menu path ->

3. General information

3.1. Current version of the operating manual



The latest version of this document is available for download on the home page!

Menu -> Downloads -> General Information

3.2. EC conformity



Your crane is CE-marked and thus complies with the requirements of the Machinery Directive and other relevant European Union directives. In the case of truck-mounted cranes, the company responsible for assembly is responsible for the EC conformity of the complete unit (truck & crane). In the event of structural changes to the crane, the assembler must reissue the EC Declaration of Conformity for the crane. Load handling equipment, such as grab, must have its own CE Mark. The crane and the load handling equipment may only be operated in the European Economic Area with a valid CE mark.

3.3. Assembly, acceptance and recurrent testing

The crane assembly must comply with the latest applicable version of DIN EN 12999. Additionally, the latest valid version of our assembly guidelines must be followed. After assembly, every crane must be inspected and approved by an independent testing body before handover to the customer.



According to the Work Equipment Ordinance (AM-VO), an annual inspection of your crane is compulsory. This may be exceeded by a maximum of 3 months.



To ensure optimum control performance of the crane, it is advisable to follow Penz crane's specifications when selecting the hydraulic pumps.
Penz crane cannot guarantee the proper functioning of the crane if the recommendations for the design of the hydraulic pumps (especially litre capacity) are not observed.

3.4. Intended use

The crane may be used in the load range, according to the load capacity diagram, in order to perform the following activities:

- Lifting loads
- Transporting loads
- Holding loads
- Setting down loads

The following activities, in particular, fall under intended use:

- Loading and unloading of your own or another vehicle.
- Raising and moving of loads below ground level.
- Raising and movement of unprocessed wood with the aid of suitable load handling equipment (e.g.: CE-compliant grab)

3.5. Unintended use

- No load may be suspended in the load handling equipment when the truck is in driving mode.
- A load that has been attached to the crane must not be pulled behind the moving truck under any circumstances.
- The crane must not be used to compress scrap or other materials on a platform or pallet. Also prohibited are all "pressing" movements, such as ramming piles into the ground or similar applications.
- It is forbidden to raise loads larger than the maximum specified on the load plate (observe load capacity diagram).
- Throwing movements with loads are forbidden. Also the sudden ejection of (partial) loads is forbidden.
- An open grab parked on a base may not be closed without first starting up the arm system and thus raising the load handling equipment from the base.
- The vehicle may not be moved with extended supports or support extensions. The vehicle may only be moved with fully retracted supports or support extensions. Furthermore, the arm system must be brought into its planned transport position. Swivelling supports must be bolted with a linchpin in crane operation and in the transport position. Manual support extensions must be retracted, the latching of the safety devices must be checked.
- Under no circumstances may the grab load be pulled over the ground in combination with a lifting movement to reach a position in which the load can be raised.
- Lifting people is absolutely forbidden. To lift people with a passenger lifting device, equipment is required to lift people as in ÖNORM EN 14502-1 and 14502-2.

- Cranes which are equipped with a telescopic lifting arm may only be used when the lifting arm is fully extended.

3.6. Lifting capacity data



The lifting loads specified by Penz crane GmbH refer to the optimum arm position. (First boom 10° and angle first boom/second boom 110°).

3.7. Data



The data provided by Penz crane GmbH are approximate values and may vary.

3.8. Product liability / information obligation

Property damage within the meaning of the Product Liability Act is damage caused by a machine, but not to it. Corporate property damage is excluded from the liability according to the Product Liability Act.

With the handover of this operating manual after initial acceptance of your crane, you will be instructed with regard to operating and safety and the maintenance instructions.

As proof of the proper handover of the crane, this operating manual and completed training, your confirmation is required on the delivery note (Attachment 1).



Even if the crane is passed on by the customer at a later date, this operating manual must be included and the new owner must be demonstrably instructed on the above-mentioned points!

3.9. Operating personnel

The crane may only be put into operation by persons who have comprehensive knowledge of the operation of the machine.



Even if the crane is passed on by the customer at a later date, this operating manual must be included and the new owner must be demonstrably instructed on the above-mentioned points!

3.9.1. Operator requirements

- Comprehensive training on this device and understanding of its contents.
- Knowledge and understanding of the contents of this operating manual.
- Knowledge and understanding of the contents of the operating manual of all additional devices used.

- Knowledge of the respective country-specific regulations, standards and laws to operate this device
- and all additional devices used.
- Physical and mental suitability.
- Legally required training, as per country-specific laws.
- No restrictions due to alcohol, drugs or medication.
- Required minimum age, as per country-specific laws.

3.9.2. Crane driver's license

Cranes above a load capacity of 50 kN and a load moment from 100 kNm can only be driven with the possession of a crane driver's license. This is defined in the FK-V (Proof of Expertise Ordinance) BGBl (Federal Law Gazette). II No. 13/2007.



A crane driver's license is not required for loading cranes whose load capacity is not more than 50 kN and load moment not more than 100 kNm. However, PENZ crane GmbH recommends that a crane operator's license be issued for the operating personnel of all cranes.

4. Safety advice and hazards

The safe operation of this device requires compliance with all subsequent information. Assess potential hazards before operation. Operating situations in which the operator or bystanders could be put at risk are to be avoided at all costs.

4.1. Personal protective equipment

The operator and all bystanders must wear adequate protective equipment. These especially include:

- Protective helmet
- Safety shoes
- Gloves

4.2. Information and prohibition symbols on the crane

Observe the danger information and prohibitions of the following symbols! The symbols are visibly attached to the crane. Their meaning must be understandable to the operator and all bystanders.



Always make sure that no one remains within a radius of 20 m during crane operation!



The control station is designed for a maximum load of 150 kg!



The slope of the ground may not exceed 7° to ensure sufficient stability.



It is forbidden to remain under suspended loads.



Load hook operation is forbidden.



Access and start-up of the crane is forbidden for unauthorised personnel.

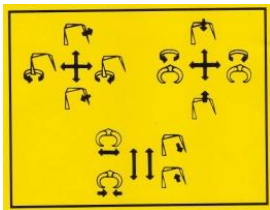

Note the functional diagram of the switching lever movements!



Please note that the symbols and danger information are legally prescribed and must be replaced if they are illegible or lost. If this is the case, please contact our customer service department.

4.3. Hazards

The following list contains the major danger situations which could pose a danger for the operator and bystanders during intended use of the machine and in the event of reasonable, foreseeable misuse.



Operation of the crane requires sufficient experience to correctly weigh up potential hazardous situations. Stop operating the crane if you don't feel up to a situation.

4.3.1. Electrical overhead lines

Always keep a minimum distance of 5 m between electrical lines and your crane. If this is not possible, the line must be de-energised before starting work. If you should come into contact with an electrical line due to incorrect estimation of the danger or other non-foreseeable circumstances, keep calm, under no circumstances touch the crane with your hands and make sure you keep both legs on the ground. Never switch on your mobile phone. Do not receive any calls on your mobile phone. Draw attention to yourself by shouting. Remain seated and wait until emergency crews are on-site.



If you should have control of the crane via a remote control, it is possible to leave the potential gradient area with both legs.



Bear in mind that stepping into the potential gradient area results in death.

Keep the required minimum distances from electrical lines. If this is not possible due to the work sequence, these lines must be disconnected (switched off). The nature and height of electrical conductors does not reveal the voltage. For electrical lines of unknown voltage, a distance of 5 m between the crane and line may not be fallen below. This also applies for all load handling equipment and additional devices attached to the crane. Bear in mind that the wind may cause an electrical line to swing out or that the articulated arm of an assembled crane may oscillate due to sudden movements (also upwards).



A current discharge can also occur even when merely approaching an electrical line.

Before setting up the crane, check whether there is an electrical overhead line within the swivel range. If this is the case, the prescribed minimum distance must be kept during the whole work process. The following table shows the required minimum distances.

Minimum distances to overhead lines	
Up to and including 1 kV	min. 1 m
Up to and including 45 kV	min. 3 m
Up to and including 110 kV	min. 4 m
Up to and including 220 kV	min. 5 m
Up to and including 380 kV	min. 6 m

4.3.2. Wind effects and thunderstorms



The permissible wind strength for crane operation lies at 80 km/h.



The crane may not be operated when a storm is approaching and during storms.

4.3.3. Risk of falling



Climbing up the crane is forbidden.

The exception to this rule is the ascent to the operator's platform via the climbing aid, as well as climbing the base for emergency control operation after failure of the remote control.

4.3.4. Burning risk

The following components become very warm during operation

- Lines
- Hoses
- Valves
- Operating lever on valves
- Hose couplings
- Hydraulic cylinder
- Oil motors
- Pumps



Maintain sufficient distance from potential heat sources!

5. Assembly of the crane

5.1. Collapsible crane (Z crane)

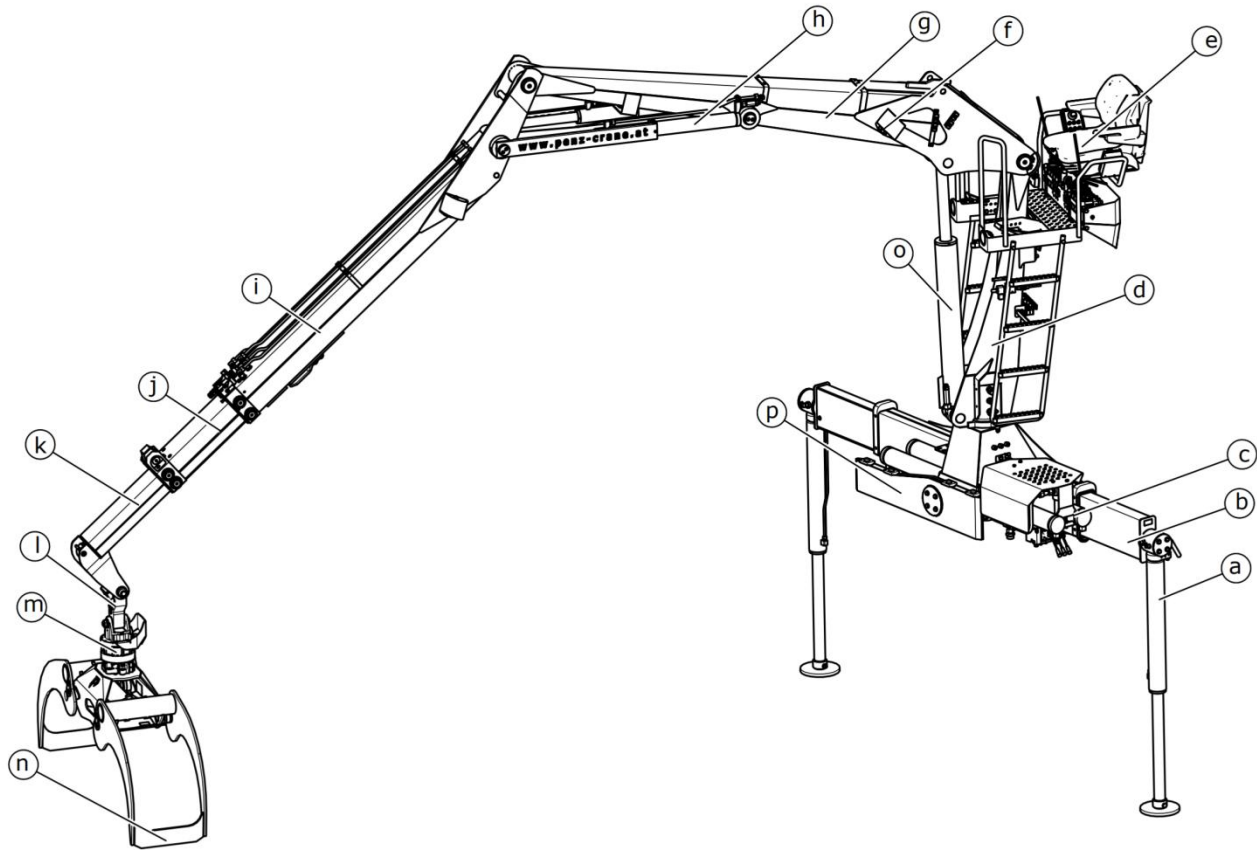

a ... Support foot (swivelling)

b ... Support extension

c ... Swivel cylinder

d ... Crane base

e ... Control

f ... Lighting

g ... Lifting arm

h ... Folding cylinder

i ... Articulated arm

j ... Extension (extension cylinder not visible)

k ... Extension 2

l ... Cross suspension

m ... Rotator

n ... Grab

o ... Lifting cylinder

p ... Three-point suspension

5.2. Open crane (L crane)

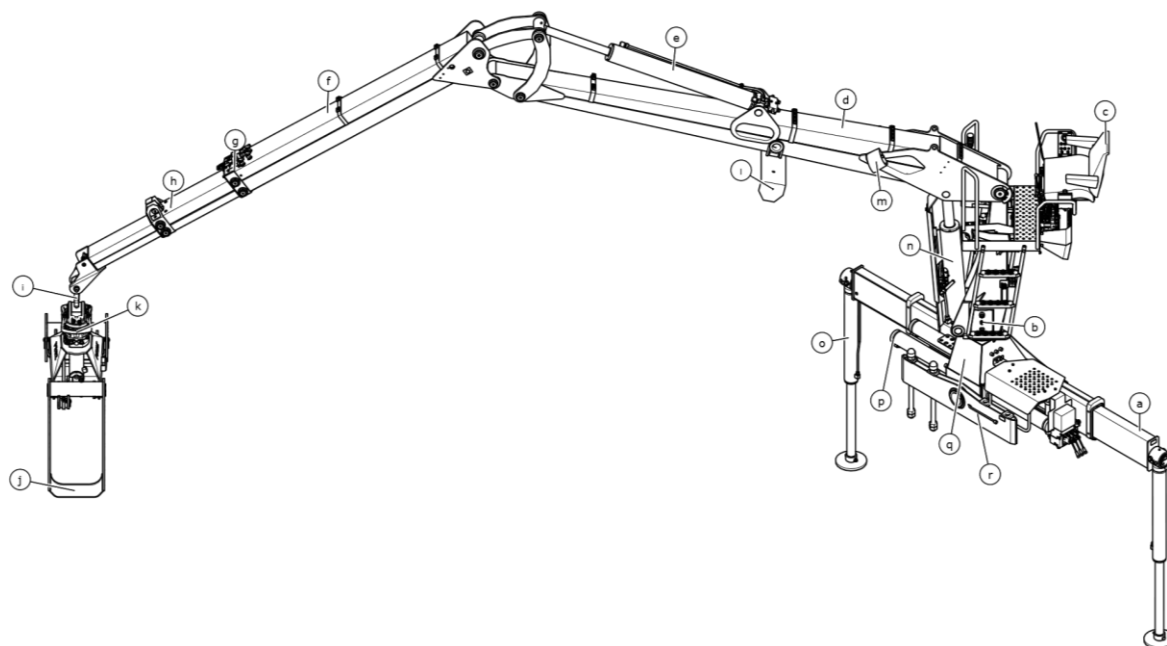

- | | |
|--|------------------------------|
| a ... Support extension | j ... Grab |
| b ... Crane base | k ... Rotator |
| c ... Control | l ... Log comb |
| d ... Lifting arm | m ... Lighting |
| e ... Folding cylinder | n ... Lifting cylinder |
| f ... Articulated arm | o ... Support cylinder |
| g ... Extension (extension cylinder not visible) | p ... Swivel cylinder |
| h ... Extension 2 | q ... Crane base |
| i ... Cross suspension | r ... Three-point suspension |

6. Safety devices

Your crane is equipped with extensive safety devices which makes operation as safe as possible according to the state-of-the-art.



Deactivation of the existing ex works safety devices is forbidden. In the case of non-existent safety devices, all liability is transferred to the operator.

- Locks against folding the articulated arm away in transport position and extension locks on mechanical support extensions. These lock prevent the articulated arm or the support extensions from moving out across the width of the vehicle while driving with the truck, thereby endangering other road users.
- With hydraulically actuated supports, lockable check valves are installed in the cylinder, which prevent the support extension from moving out across the width of the vehicle while driving the truck.
- Swivelling supports are equipped with a linchpin. Swivelling supports must be bolted with this linchpin in crane operation and in the transport position.
- A main pressure valve is built into the inlet section of the control block, set to maximum pressure in the factory and sealed. Furthermore, nearly all control functions are fitted with individual secondary valves to limit the pressure in the individual cylinder circuits and to prevent impact movements.
- The cylinder circuits of the lifting cylinder, articulated cylinder and extension cylinder are secured with hose rupture valves. The support feet are fitted with lockable check valves.
- The majority of the hoses are provided with splash guard hoses.
- As overload safeguard, either a load moment limitation (LMB) or a pressure gauge are installed, which prevent or optically indicate that the performance limit of the crane has been reached. The load moment limitation reacts at 105% load, the pilot lamp illuminates at 90% of load reached.
- Throttle valves in control sections or chokes prevent high lowering speeds.
- An emergency stop button is installed in the immediate vicinity of the operating station. The emergency stop button is to be activated in dangerous situations. Also the emergency stop button is always to be activated when not working with the crane (e.g. moving the truck, maintenance work, work breaks). Check the functionality of the crane before starting up.

6.1. Inclination monitoring

For recycling class cranes, inclination monitoring is built in. The functionality is described in the following.

The following ground properties must be checked for the required stability.

- Firmness
- Distance to terrain edges



The ground inclination (= vehicle inclination) may not exceed 5°.

6.1.1. Inclination sensor (B2, B3)

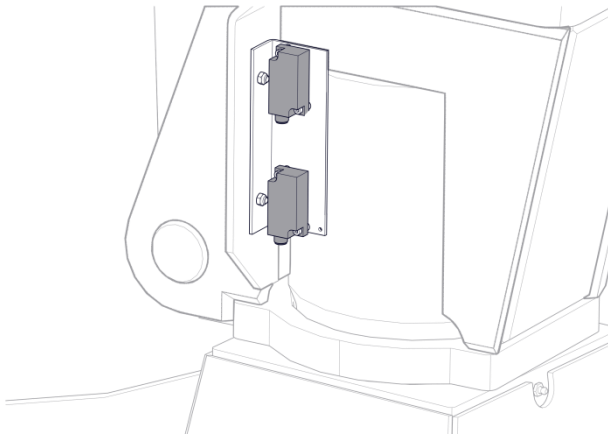

The inclination sensors monitor the stability of the crane unit on the vehicle via two programmable switching points. When exceeding the permissible inclination (defined and set from factory), all load and tilting-moment-increasing functions (also swivelling the crane) are locked. Determination of the inclination takes place via a non-wearing semiconductor sensor element. The LED indicators give information about the operating voltage indicator (green) and the switching state indicators (2 x yellow). Check the functionality of the crane before starting up (green lamp).

6.1.2. Functional principle of the stability monitoring

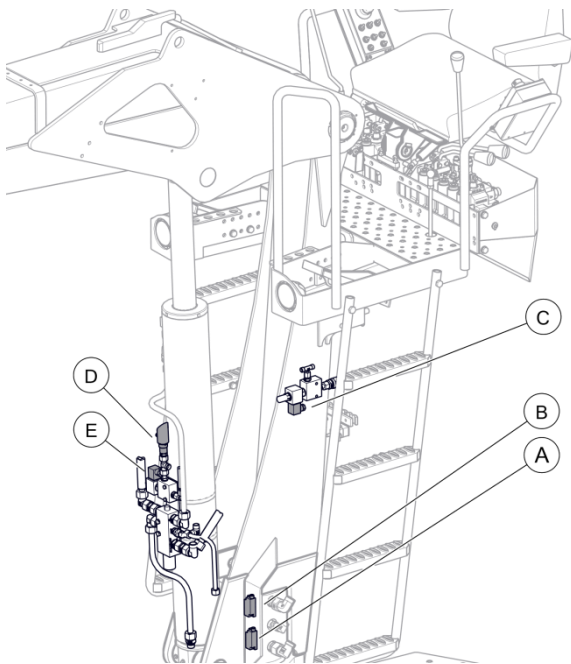

In the event of

- exceeding the factory-defined and set permissible inclination ($7^\circ = 105\%$) of both inclination sensors (A, B) and/or
- reaching the factory-defined and set max. permissible lifting load - capacity (105% of the operating pressure)

switch outlet 2 opens on pressure sensor (D).

This de-energises the two solenoid valves (C, E), which pressurises the overload cylinders flanged to the valve block for the main crane functions. This blocks the slide rods (control lever) of the load and tilt moment increasing functions (also swivelling the crane) in neutral position. When this safety device is active, only load and tilt-moment-reducing movements are possible, such as retracting telescope or lowering articulated arm.



If the load and tilt-moment-reducing movements cannot be executed due to the crane position, there is the option of consciously re-enabling certain locked functions with the "Safety Quit" button.



The "Safety Quit" button may only be activated in an emergency and is not permitted for permanent operation under any circumstances. When operating the crane with the "Safety Quit" button, the responsibility for the stability is transferred from the crane manufacturer to the crane driver, as the stability of the vehicle can no longer be guaranteed in the event of misuse.

6.2. Overload protection

As overload protection for wood loading cranes, a secondary pressure limiter, or for recycling class cranes a load moment limiter (LMB) is installed, which prevents or optically indicates that the performance limit of the crane has been reached. The load moment limiter reacts at 105% load. In both cases, the tower lighting device (yellow, red) serves as optical indicator.

6.2.1. Towerlight

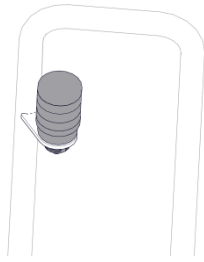

When 90% of the load capacity is reached, the yellow light (lower light section) lights up. If the crane is loaded beyond its designated load capacity, the red light illuminates (upper light section) and thus signals that the load moment must be reduced.

6.2.2. Pressure sensor

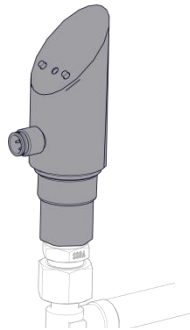

A pressure sensor measures the pressure on the lifting cylinder and passes the signals (90% capacity-yellow LED, LMB overload/shutdown pressure- red LED) on to the Towerlight via its transistor outputs. When reaching the max. permissible capacity (105% of operating pressure - defined and set from factory), all load and tilting-moment-increasing functions (also swivelling the crane) are locked.

6.3. Support and height monitoring

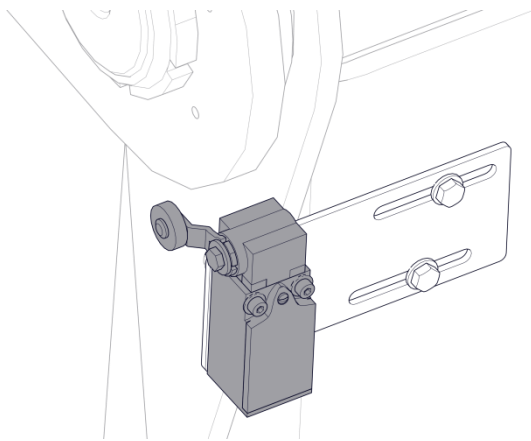

This electromechanical position switch handles support and height monitoring. If the max. permissible vehicle height is exceeded, a visible and audible indicator must indicate this in the vehicle cab (driver's cab). If the support extensions are not in the transport position, a visible and audible warning device must indicate this in the vehicle cab (driver's cab).

7. Safety guidelines

7.1. Safety guidelines before each start-up of the crane



The crane may not be put into operation with obvious defects!

7.1.1. Defects to be checked before every crane start-up



Check the crane before every start-up for the following defects. Start-up is only allowed after eliminating defective components.

- Defective lubrication
- Damage or cracks in components and welding seams
- Defect bearing points
- Defects in the hydraulic system (leaks, unusually strong warming, etc.)
- Defects in safety devices
- Loose screw connections
- Insufficiently secured bolts
- Malfunctions of hose unwinding in the hose reel or hose tray
- Unusual noises
- Unusually fast or slow working movements
- Functional fault on the control
- Lack of smooth running and/or self-resetting of the operating elements
- Check the load handling equipment for correct fastening
- Emergency stop button
- Inclination sensor

7.1.2. Suitability and ability of the crane operator to operate the crane



Find out the position of the emergency stop switch. Depending on the control, this may vary.



Ensure your personal protective equipment is complete

7.1.3. Work preparation



Secure the vehicle against rolling away (engage the hand brake and use chocks).

- Check the correct adjustment of the seat position and complete latching of the seat.
- Handles and steps must be free of dirt, oil, ice and snow.

7.1.4. Working environment



Keep your distance from electrical overhead lines (see 4.3.1 Electrical overhead lines).



Ensure that no one remains in the work area.

- At dusk or at night, the entire work area is to be adequately lit.
- Paths which cross the work area must be blocked during crane operation.

7.1.5. Vehicle surface and stability

- Make sure that the inclination of the surface (vehicle inclination) is not more than 5°.
- Check the ground for any cavities (drain covers, pipelines etc.) which could endanger the stability.
- Check whether there is sufficient distance to terrain edges.
- Check the surface for sufficient stability. If the surface does not have the required solidity, use a location with sufficient solidity and/or use underlay plates which reduce the surface pressure on the surface.
- Penz crane recommends using additional underlay plates under the support to avoid indentations or damage to the surface. (Especially on asphalt)

Permissible ground pressure (capacity of the ground) according to DIN1054

Filled, not artificially compacted ground	0-10 N/cm ²
Asphalt	20 N/cm ²
Grown, obviously undisturbed ground	

	Mud, peat, moorland	0 N/cm ²
Non-cohesive, sufficiently solidly stored soils		
	Fine to medium sand	15 N/cm ²
	coarse sand to gravel	20 N/cm ²
	Ballast compacted	25 N/cm ²
Cohesive soils		
	mushy	0 N/cm ²
	soft	4 N/cm ²
	firm	10 N/cm ²
	semi-solid	20 N/cm ²
	solid	30 N/cm ²
Rock		
	weathered	100 N/cm ²

7.1.6. Supporting the vehicle



Before extending the support extensions, ensure that no people or obstacles are in the danger area.

- Extend the support extensions fully until the marking is visible.



- Support extensions which are pulled out manually must be locked with the extension lock.
- Ensure that the support surface corresponds to the condition of the ground. If necessary, enlarge the support surface with suitable support plates.
- Extend the support legs until the vehicle has been raised 3-4 cm.



The support of the crane is only designed to raise the load moment. Never lift out the vehicle! The wheels must never lose contact with the ground!



Make sure that, if available, the swivelling supports are bolted via linchpin.

7.2. Safety guidelines during crane operation

7.2.1. Defects to be checked during crane operation

- Watch out for unusual noises and changes of the working speed.
- Watch out for functional faults on the control!
- Check the hydraulic components for unusually high warming.
- If oil should spray out of a hydraulic line, stop the crane immediately and fix the leak. Note that an oil jet can already enter the body with a pressure of 30 bar and can cause poisoning.





7.2.2. Moving the crane and working with loads

- During crane operation, the supports may not be retracted under any circumstances as this can lead to a loss of stability.
- Never perform sudden crane movements since this could cause the load to vibrate and fall down.
- If the crane is operated with several functions at the same time, watch out because the speed of movement of the other functions may increase when a function is switched off.
- While the load is being lowered from a steep position, the reach must not be increased, as this may cause the permissible load to be exceeded and an uncontrolled fall may occur.
- Never exceed the load limits specified in the load diagram. The largest load specified in the load diagram corresponds to the maximum permissible lifting load of the crane. Note that the load handling equipment is part of the lifting load.
- Never exceed the permissible loads on the additional devices (rotator, grab, etc.).
- Note that activation of the emergency stop button shorts the oil supply to the crane
- . If your crane is designed as a wood loading crane, certain movements of the crane such as lowering the lifting arm, lowering the articulated arm and extending the extension are still possible.
- During loading and unloading, the load must be prevented from moving over buildings, vehicles or other valuable objects. Loosening and possible falling of a trunk of wood from the grab could lead to damage, which may not be covered by insurance under certain circumstances. All movements of the load over the driver and third parties is strictly forbidden.
- If you have to interrupt crane work and leave the crane unattended, the load is to be set aside and the crane lowered. Furthermore, the emergency stop button is to be activated and the hydraulic pump turned off. Before restarting crane work, make sure that no manipulation was carried out and the points named above have been met.

- Pay attention to oscillating load movements. These endanger not only adjacent objects but also your crane and your vehicle. Always grip the load at its centre of gravity.

7.2.3. Personal protection and the protection of bystanders

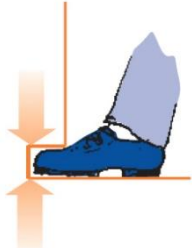
- Make sure that no one remains within the danger area of the crane (20 m).
- Ensure adequate lighting.
- Before starting crane work, make sure that you have sufficient visibility in all required areas.
- Note the temperature of hydraulic components, such as control devices, hoses, pipes, hose couplings, hydraulic cylinder and pumps, before touching them. The hydraulic flow can heat up these components, which could cause burns.
- Avoid operating situations which could lead to crushing risks for you or for bystanders from the crane, supports, cargo or load. The crushing point is not considered a danger area for the specified body parts if the safety distances shown below are not fallen short of and if it is ensured that the next largest part of the body cannot get inside.

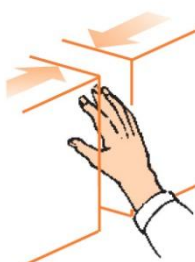
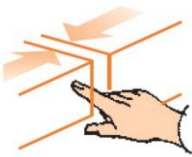
Required minimum distances as per DIN EN 349			
Body ≥ 500	Leg ≥ 180	Foot ≥ 120	Toes ≥ 50
			
Head ≥ 300	Arm ≥ 120	Hand ≥ 100	Finger ≥ 25
			

7.3. Safety guidelines according to crane operation

- Before moving the carrier vehicle, always bring the crane into the transport position. Ensure that no people or objects are in the danger area. Check that the cargo is secured accordingly, and that there are no loose, unsecured parts on the crane and on the vehicle.
- For a collapsible crane, make sure that the arm lock and the grab are properly locked (see **Fehler! Unbekanntes Schalterargument.Fehler! Unbekanntes Schalterargument.**).
- Fully retract the support and check that it is also locked.
- Make sure that swivelling supports are bolted via linch pins.
- Activate the emergency stop switch to avoid uncontrolled crane movements at restart.
- Fold the seat forward into the transport position. If you should have a cab on your crane, ensure that the doors close properly. If your crane is equipped with a weather cover, secure the weather cover so that the weather cover cannot move out of the transport position while driving.
- Ensure that the auxiliary gearbox with hydraulic pump is in an uncoupled state.
- Observe the permissible total weight, the permissible axle loads as well as the country-specific passage heights of underpasses and electrical lines. Always observe the respective legal maximum vehicle width.



Before departure, ensure that all locking devices are fully locked.

8. Controlling the crane



Familiarise yourself with the control system before starting crane operation.

The following chapter describes standard versions of controls.



If you have ordered a special crane control system, find the supplementary sheet "Special crane control" in the appendix of this operating manual. The supplementary sheet explains the desired operating functions.

8.1. Cross lever control

The following image shows the operator's view of the operating elements of a cross lever control. The movements are represented by grey symbols. Depending on how you wish to equip your crane, the design of your control may deviate from the representation.

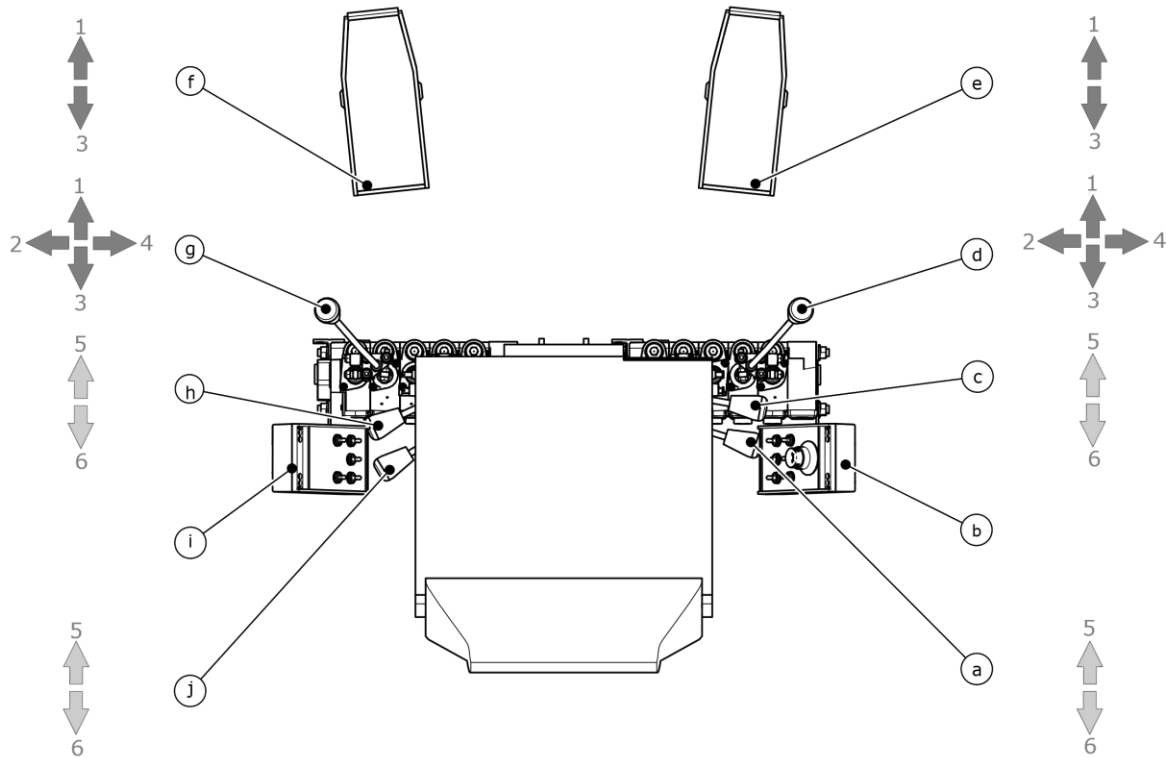



Operating elements





- | | |
|--|---|
| a ... Foot pedal (left) | f ... Foot pedal (right) |
| b ... Cross lever (left) | g ... Cross lever (right) |
| c ... Linear lever (under seat, left, front) | h ... Linear lever (under seat, right, front) |
| d ... Switch housing (left) | i ... Switch housing (right) |
| e ... Linear lever (under seat, left, rear) | j ... Linear lever (under seat, right, rear) |

Movements



- | | |
|-----------------|-----------------|
| 1 ... FORWARDS | 4 ... RIGHT |
| 2 ... LEFT | 5 ... UP |
| 3 ... BACKWARDS | 6 ... DOWNWARDS |



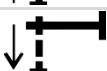

8.1.1. Design: narrow support, controlled hydraulically

Foot pedal (left)		
FORWARDS	Open grab	
BACKWARDS	Close grab	



Cross lever (left)		
FORWARDS	Lower articulated arm	
LEFT	Swivel crane column anti-clockwise	
BACKWARDS	Raise articulated arm	
RIGHT	Swivel crane column clockwise	

Linear lever (under seat, left, front)		
UP	Retract support cylinder left	
DOWNWARDS	Extend support cylinder left	

Foot pedal (right)		
UP	Extend extension	
DOWNWARDS	Retract extension	

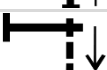
Cross lever (right)		
FORWARDS	Lower lifting arm	
LEFT	Rotate rotator anti-clockwise	
BACKWARDS	Raise lifting arm	
RIGHT	Rotate rotator clockwise	

Linear lever (under seat, right, front)		
UP	Retract support cylinder right	
DOWNWARDS	Extend support cylinder right	









Linear lever (under seat, right, rear)		
UP	Retract support extension on both sides	
DOWNWARDS	Extend support extension on both sides	

The crane control system has a switch housing on the right side to operate the basic electrical functions.









The emergency stop switch is centrally located on top of the right switch housing.

The functions of the toggle switch are described in the following table.



Functions of the toggle switch	
	Hydraulic pump
	SafetyQuit (only for cranes with stability monitoring)
	Speed control for crane operation
	Lighting
	p+ (only for cranes with pressure increase)
	Seat heating
	Radio
	Additional function



8.1.2. Design: broad support, controlled hydraulically

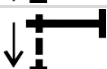



Foot pedal (left)		
FORWARDS	Open grab	
BACKWARDS	Close grab	

Cross lever (left)		
FORWARDS	Lower articulated arm	
LEFT	Swivel crane column anti-clockwise	
BACKWARDS	Raise articulated arm	
RIGHT	Swivel crane column clockwise	



Linear lever (under seat, left, front)		
UP	Retract support cylinder left	
DOWNWARDS	Extend support cylinder left	

Linear lever (under seat, left, rear)		
UP	Retract support extension left	
DOWNWARDS	Extend support extension left	

Foot pedal (right)		
UP	Extend extension	
DOWNWARDS	Retract extension	

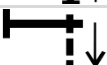
Cross lever (right)		
FORWARDS	Lower lifting arm	
LEFT	Rotate rotator anti-clockwise	
BACKWARDS	Raise lifting arm	
RIGHT	Rotate rotator clockwise	

Linear lever (under seat, right, front)		
UP	Retract support cylinder right	
DOWNWARDS	Extend support cylinder right	









Linear lever (under seat, right, rear)		
UP	Retract support extension right	
DOWNWARDS	Extend right support extension	

The crane control system has a switch housing on the right side to operate the basic electrical functions.









The emergency stop switch is centrally located on top of the right switch housing.



The functions of the toggle switch are described in the following table.





Functions of the toggle switch	
	Hydraulic pump
	SafetyQuit (only for cranes with stability monitoring)
	Speed control for crane operation
	Lighting
	p+ (only for cranes with pressure increase)
	Seat heating
	Radio
	Additional function

8.1.3. Design: narrow or broad support, controlled electrically



Foot pedal (left)		
FORWARDS	Open grab	
BACKWARDS	Close grab	

Cross lever (left)		
FORWARDS	Lower articulated arm	
LEFT	Swivel crane column anti-clockwise	
BACKWARDS	Raise articulated arm	
RIGHT	Swivel crane column clockwise	

Foot pedal (right)		
UP	Extend extension	
DOWNWARDS	Retract extension	

Cross lever (right)		
FORWARDS	Lower lifting arm	
LEFT	Rotate rotator anti-clockwise	
BACKWARDS	Raise lifting arm	
RIGHT	Rotate rotator clockwise	

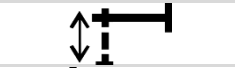
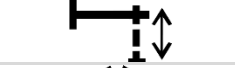
The switch housing on the left side controls the supports.









Symbol on switch housing	Narrow support	Broad support
	Support extension on both sides	Support extension left
	Support cylinder left	Support cylinder left
	Support cylinder right	Support cylinder right
	[not assigned]	Right support extension

The crane control system has a switch housing on the right side to operate the basic electrical functions.



The emergency stop switch is centrally located on top of the right switch housing.

The functions of the toggle switch are described in the following table.

Functions of the toggle switch	
	Hydraulic pump
	SafetyQuit (only for cranes with stability monitoring)
	Speed control for crane operation
	Lighting
	p+ (only for cranes with pressure increase)
	Seat heating
	Radio
	Additional function

8.2. Cross lever control

The following image shows the operator's view of the operating elements of a four-lever control. The movements are represented by grey symbols. Depending on how you wish to equip your crane, the design of your control system may deviate from the representation.

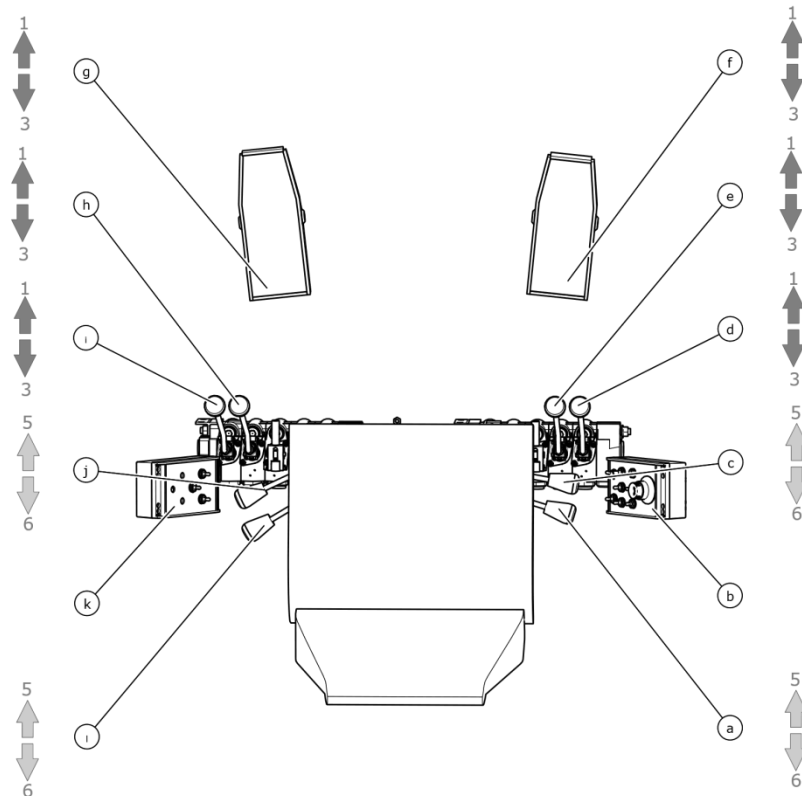



Operating elements



- | | |
|--|---|
| a ... Foot pedal (left) | g ... Foot pedal (right) |
| b ... Linear lever (left, inside) | h ... Linear lever (right, inside) |
| c ... Linear lever (left, outside) | i ... Linear lever (right, outside) |
| d ... Linear lever (under seat, left, front) | j ... Linear lever (under seat, right, front) |
| e ... Switch housing (left) | k ... Switch housing (right) |
| f ... Linear lever (under seat, left, rear) | l ... Linear lever (under seat, right, rear) |



Movements



- | | |
|-----------------|-----------------|
| 1 ... FORWARDS | 4 ... RIGHT |
| 2 ... LEFT | 5 ... UP |
| 3 ... BACKWARDS | 6 ... DOWNWARDS |



8.2.1. Design: narrow support, controlled hydraulically



Foot pedal (left)		
FORWARDS	Lower lifting arm	
BACKWARDS	Raise lifting arm	



Linear lever (left, inside)		
FORWARDS	Open grab	
BACKWARDS	Close grab	



Linear lever (left, outside)		
FORWARDS	Swivel crane column clockwise	
BACKWARDS	Swivel crane column anti-clockwise	



Linear lever (under seat, left, front)		
UP	Retract support cylinder left	
DOWNWARDS	Extend support cylinder left	

Foot pedal (right)		
UP	Extend extension	
DOWNWARDS	Retract extension	

Linear lever (right, inside)		
FORWARDS	Raise articulated arm	
BACKWARDS	Lower articulated arm	

Linear lever (right, outside)		
FORWARDS	Rotate rotator anti-clockwise	
BACKWARDS	Rotate rotator clockwise	

Linear lever (under seat, right, front)		
UP	Retract support cylinder right	
DOWNWARDS	Extend support cylinder right	









Linear lever (under seat, right, rear)		
UP	Retract support extension on both sides	
DOWNWARDS	Extend support extension on both sides	

The crane control system has a switch housing on the right side to operate the basic electrical functions.







The emergency stop switch is centrally located on top of the right switch housing.



The functions of the toggle switch are described in the following table.



Functions of the toggle switch	
	Hydraulic pump
	SafetyQuit (only for cranes with stability monitoring)
	Speed control for crane operation
	Lighting
	p+ (only for cranes with pressure increase)
	Seat heating
	Radio
	Additional function



8.2.2. Design: broad support, controlled hydraulically



Foot pedal (left)		
FORWARDS	Lower lifting arm	
BACKWARDS	Raise lifting arm	



Linear lever (left, inside)		
FORWARDS	Open grab	
BACKWARDS	Close grab	



Linear lever (left, outside)		
FORWARDS	Swivel crane column clockwise	
BACKWARDS	Swivel crane column anti-clockwise	

Linear lever (under seat, left, front)		
UP	Retract support cylinder left	
DOWNWARDS	Extend support cylinder left	



Linear lever (under seat, left, rear)		
UP	Retract support extension left	
DOWNWARDS	Extend support extension left	

Foot pedal (right)		
UP	Extend extension	
DOWNWARDS	Retract extension	

Linear lever (right, inside)		
FORWARDS	Raise articulated arm	
BACKWARDS	Lower articulated arm	

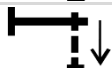
Linear lever (right, outside)		
FORWARDS	Rotate rotator anti-clockwise	
BACKWARDS	Rotate rotator clockwise	

Linear lever (under seat, right, front)		
UP	Retract support cylinder right	
DOWNWARDS	Extend support cylinder right	









Linear lever (under seat, right, rear)		
UP	Retract support extension right	
DOWNWARDS	Extend right support extension	

The crane control system has a switch housing on the right side to operate the basic electrical functions.





The emergency stop switch is centrally located on top of the right switch housing.



The functions of the toggle switch are described in the following table.



Functions of the toggle switch	
	Hydraulic pump
	SafetyQuit (only for cranes with stability monitoring)
	Speed control for crane operation
	Lighting
	p+ (only for cranes with pressure increase)
	Seat heating
	Radio
	Additional function



8.2.3. Design: support controlled electrically



Foot pedal (left)		
FORWARDS	Lower lifting arm	
BACKWARDS	Raise lifting arm	

Linear lever (left, inside)		
FORWARDS	Open grab	
BACKWARDS	Close grab	



Linear lever (left, outside)		
FORWARDS	Swivel crane column clockwise	
BACKWARDS	Swivel crane column anti-clockwise	

Foot pedal (right)		
UP	Extend extension	
DOWNWARDS	Retract extension	

Linear lever (right, inside)		
FORWARDS	Raise articulated arm	
BACKWARDS	Lower articulated arm	

Linear lever (right, outside)		
FORWARDS	Rotate rotator anti-clockwise	
BACKWARDS	Rotate rotator clockwise	

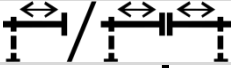
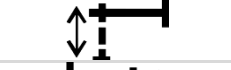
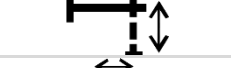
The switch housing on the left side controls the supports.









Symbol on switch housing	Narrow support	Broad support
	Support extension on both sides	Support extension left
	Support cylinder left	Support cylinder left
	Support cylinder right	Support cylinder right
	[not assigned]	Right support extension

The crane control system has a switch housing on the right side to operate the basic electrical functions.



The emergency stop switch is centrally located on top of the right switch housing.

The functions of the toggle switch are described in the following table.

Functions of the toggle switch	
	Hydraulic pump
	SafetyQuit (only for cranes with stability monitoring)
	Speed control for crane operation
	Lighting
	p+ (only for cranes with pressure increase)
	Seat heating
	Radio
	Additional function

8.3. Hydraulic pilot control

The following image shows the operator's view of the operating elements of a hydraulic pilot control system. The movements are represented by grey symbols.

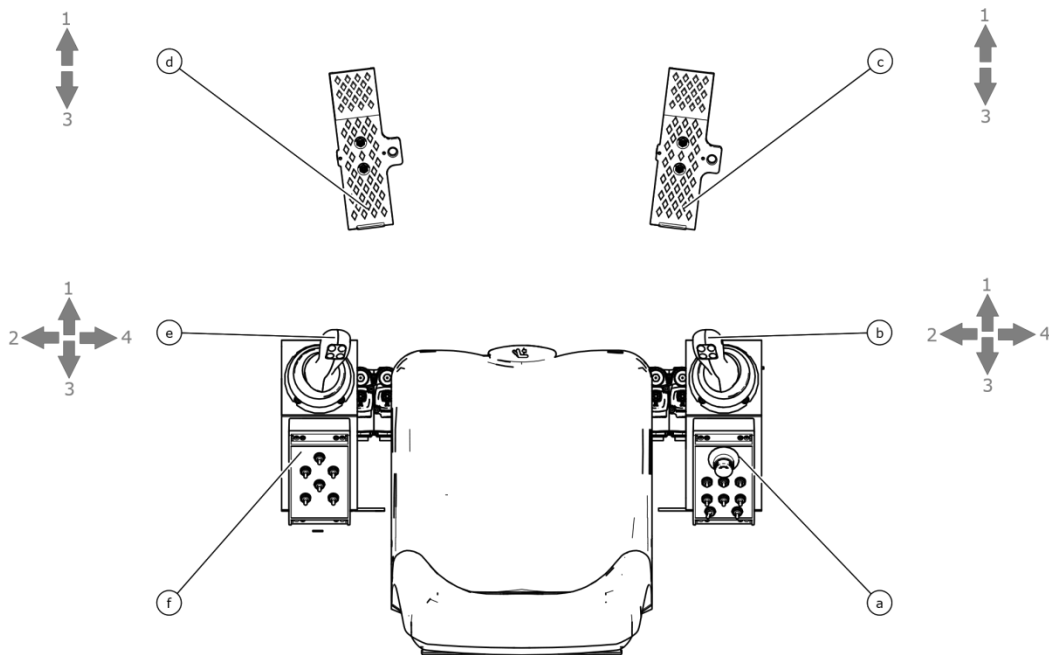

Operating elements





- | | |
|-----------------------------|------------------------------|
| a ... Foot pedal (left) | d ... Foot pedal (right) |
| b ... Joystick (left) | f ... Joystick (right) |
| c ... Switch housing (left) | g ... Switch housing (right) |



Movements





- | | |
|-----------------|-----------------|
| 1 ... FORWARDS | 4 ... RIGHT |
| 2 ... LEFT | 5 ... UP |
| 3 ... BACKWARDS | 6 ... DOWNWARDS |

8.3.1. Design



Foot pedal (left)		
FORWARDS	Open grab	
BACKWARDS	Close grab	

Joystick (left)		
FORWARDS	Lower articulated arm	
LEFT	Swivel crane column anti-clockwise	
BACKWARDS	Raise articulated arm	
RIGHT	Swivel crane column clockwise	

Foot pedal (right)		
UP	Extend extension	
DOWNWARDS	Retract extension	

Joystick (right)		
FORWARDS	Lower lifting arm	
LEFT	Rotate rotator anti-clockwise	
BACKWARDS	Raise lifting arm	
RIGHT	Rotate rotator clockwise	

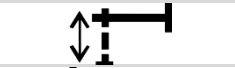
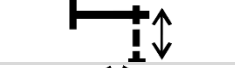
The switch housing on the left side controls the supports.









Symbol on switch housing	Narrow support	Broad support
	Support extension on both sides	Support extension left
	Support cylinder left	Support cylinder left
	Support cylinder right	Support cylinder right
	[not assigned]	Right support extension

The crane control system has a switch housing on the right side to operate the basic electrical functions.



The emergency stop switch is centrally located on top of the right switch housing.

The functions of the toggle switch are described in the following table.

Functions of the toggle switch	
	Hydraulic pump
	SafetyQuit (only for cranes with stability monitoring)
	Speed control for crane operation
	Lighting
	p+ (only for cranes with pressure increase)
	Seat heating
	Radio
	Additional function

8.4. Electrical pilot control

The following image shows the operator's view of the operating elements of an electric pilot control system. The movements are represented by grey symbols.

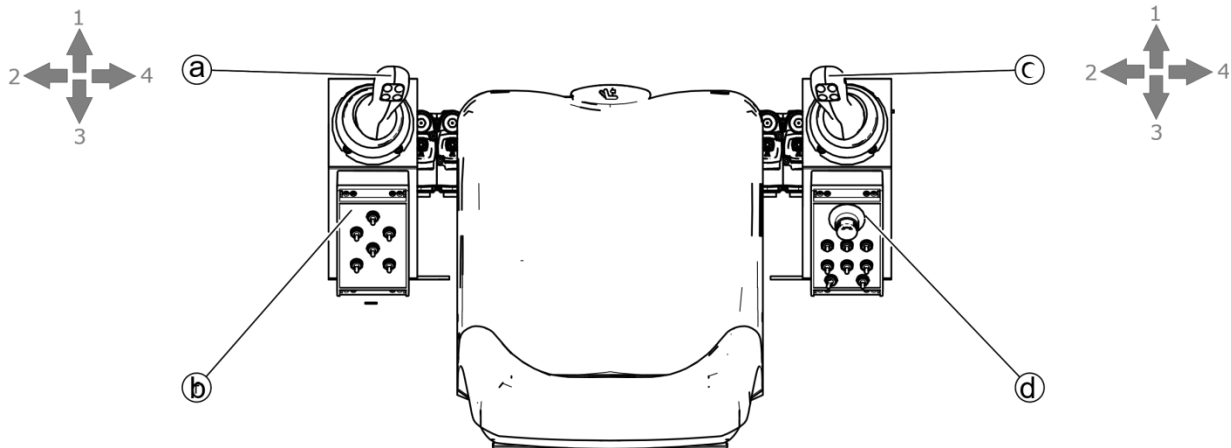





Operating elements





- a ... Joystick (left)
- b ... Switch housing (left)
- c ... Joystick (right)
- d ... Switch housing (right)

Movements

- 1 ... FORWARDS
- 2 ... LEFT
- 3 ... BACKWARDS
- 4 ... RIGHT
- 5 ... UP
- 6 ... DOWNWARDS

8.4.1. Design

Joystick (left)		
FORWARDS	Lower articulated arm	
LEFT	Swivel crane column anti-clockwise	
BACKWARDS	Raise articulated arm	
RIGHT	Swivel crane column clockwise	

Joystick (right)		
FORWARDS	Lower lifting arm	
LEFT	Rotate rotator anti-clockwise	
BACKWARDS	Raise lifting arm	
RIGHT	Rotate rotator clockwise	

Extension and grab are controlled by thumb wheels on the joystick.

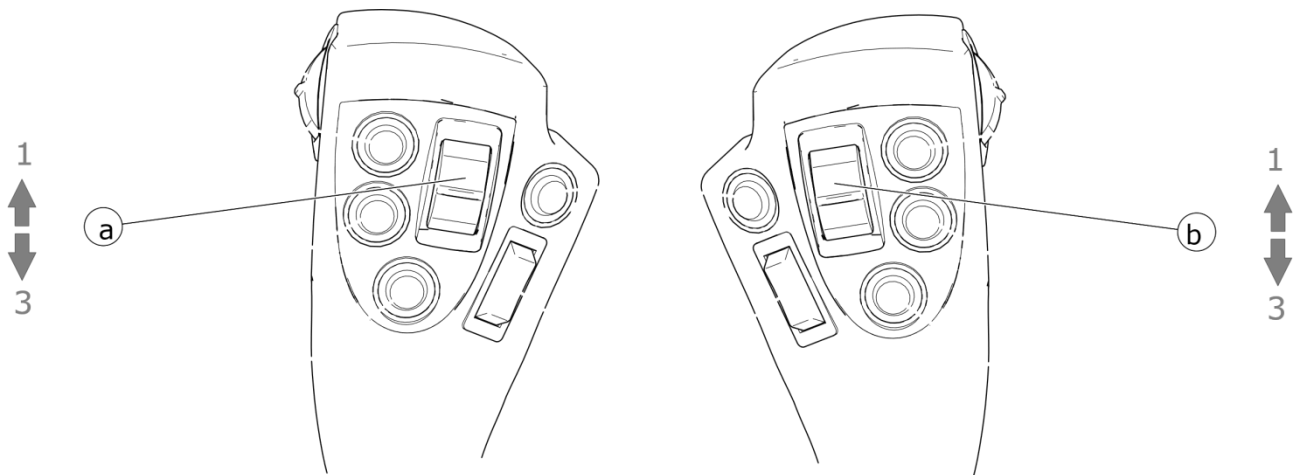

Operating elements

a ... Thumb wheel (left)

b ... Thumb wheel (right)

Movements

- 1 ... FORWARDS
- 2 ... LEFT
- 3 ... BACKWARDS

- 4 ... RIGHT
- 5 ... UP
- 6 ... DOWNWARDS

Thumb wheel (left)		
FORWARDS	Open grab	
BACKWARDS	Close grab	

Thumb wheel (right)		
FORWARDS	Extend extension	
BACKWARDS	Retract extension	

The switch housing on the left side controls the supports.









Symbol on switch housing	Narrow support	Broad support
	Support extension on both sides	Support extension left
	Support cylinder left	Support cylinder left
	Support cylinder right	Support cylinder right
	[not assigned]	Right support extension

The crane control system has a switch housing on the right side to operate the basic electrical functions.



The emergency stop switch is centrally located on top of the right switch housing.

The functions of the toggle switch are described in the following table.

Functions of the toggle switch	
	Hydraulic pump
	SafetyQuit (only for cranes with stability monitoring)
	Speed control for crane operation
	Lighting
	p+ (only for cranes with pressure increase)
	Seat heating
	Radio
	Additional function

9. Crane operation

Please note the following information to ensure safe crane operation.



Follow the safety guidelines (see 7 Safety guidelines).



Working and all overhead movements of the crane are prohibited. This also applies to disassembly and assembly.

Non-observance could be life-threatening for the operator and others.

9.1. Preparing crane operation

- Park the vehicle as close as possible to the loading/unloading point.



Work with the lowest possible jib length in order to keep the stress on the crane as low as possible. This increases work safety and the lifetime of the crane.

- Move the seat into the working position.
- Switch on speed control.
- Switch on the hydraulic unit.
- Support the vehicle. Follow the safety guidelines when doing so (see 7.1.6 **Fehler! Unbekanntes Schalterargument.**).

9.2. Putting the crane into operation

9.2.1. Starting up at low temperatures

Starting up at lower temperatures (below freezing point) entails a higher degree of wear. In order to keep this wear low, observe the following points during start-up.

- Only engage the hydraulic pump at the lowest engine speed.
- Let the hydraulic oil flow through depressurised for 5 – 10 min to raise its temperature.



Do not actuate any valves during this "warm-up" phase.

- Move the crane into its working position at reduced speed.
- Now start the loading activity.

9.2.2. When disassembling the crane, bring it into the working position (Z-crane)



Make sure that the vehicle is properly supported (see 7.1.6 **Fehler! Unbekanntes Schalterargument.**).

With the procedure described below, you can bring your collapsible crane into the working position.



To avoid consequential damage, follow the procedure below exactly in the order described.

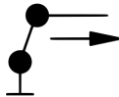
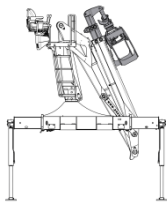

Extend the extension until the grab and the first extension move out of the transport lock.

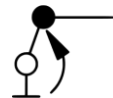

Raise the lifting arm slightly to lift the load arm from the support.

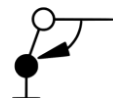
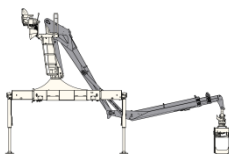

Lower the articulated arm until the grab lies safely on the ground.

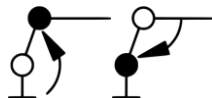
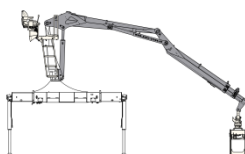

At the same time, raise the lifting arm and tilt the articulated arm to drive over the dead point of the articulated joint. The grab must remain on the ground while doing so

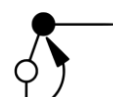
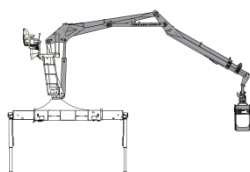

Raise the lifting arm further in order to safely bring the load arm into the required working position.

9.3. Crane working position

The load-bearing capacity and the lifetime of a crane depends on the working position. Through unfavourable positions:

- bearings, joints and crane components are subjected to higher loads and more wear and tear.
- the full load-bearing capacity is not reached.
- wear is increased.

The crane should be in an optimum working position during all tasks.

9.3.1. Working range

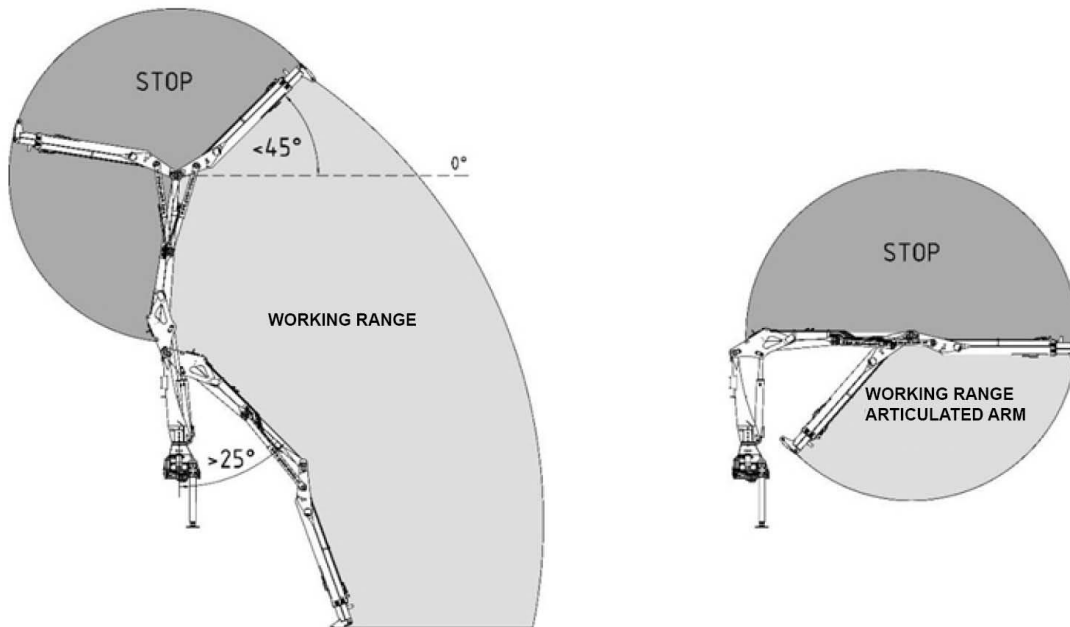

The articulated arm may not work at over 45° to the horizontal when loaded (the grab, rotator and cross suspension count as loads, even if the grab is empty). During work, the angle between lifting arm and articulated arm may never exceed 180° (i.e. the articulated arm may not be overstretched upwards). Non-observance could be life-threatening for the operator and others.



A working position with the lifting arm on the lower end stop is forbidden. In this position, the crane can be overloaded and damaged. This can lead to the load falling. Non-observance could be life-threatening for the operator and others.



Working and all overhead movements of the crane are prohibited. This also applies to disassembly and assembly. Non-observance could be life-threatening for the operator and others.

9.4. Working with loads

9.4.1. Load limits



Exceeding the permissible reach, load capacity and/or maximum load is prohibited. This can lead to the crane tipping over and to the breakage of crane components. This is life-threatening.

A load capacity plate is attached to the crane column. It gives information about the maximum possible load in the most favourable lifting arm position (angle of approx. 20° to the horizontal plane). The following image shows the position of the load capacity plate as well as the optimum position of the lifting arm.

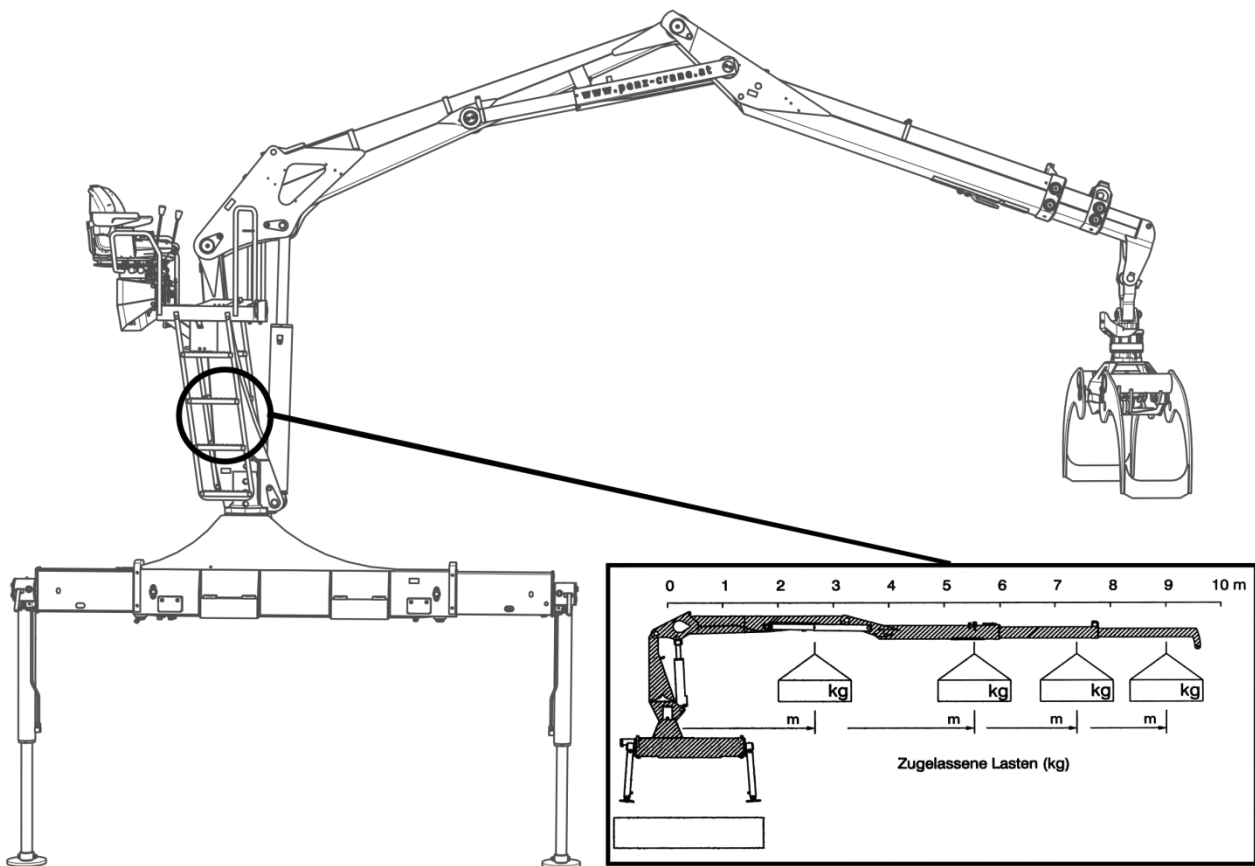

9.4.2. Raise and move load

- Carry out all crane movements gently.
- Avoid sudden movements of the load to prevent the load from swinging.
- Note the load display (Towerlight).



Do not move the crane functions into the stop position at full working speed. It increases the wear of components and is a life-threatening danger for the operator and others.



Standing under suspended loads is prohibited. The grab, rotator and cross suspension count as loads, even if the grab is empty. Non-observance could be life-threatening for the operator and others.

9.4.3. Interrupt loading/unloading activity

If it is necessary to leave the crane unattended, follow these steps:

- Put down the load.
- Set down the load arm properly.
- Switch off the crane.
- Secure the crane against unauthorised start-up.

9.5. Stop crane operation

9.5.1. Collapsing the crane, bringing the crane into the transport position (Z-crane)



Make sure that the vehicle is properly supported (see 7.1.6 **Fehler! Unbekanntes Schalterargument.**).

With the procedure described below, you can bring your collapsible crane into the transport position.



To avoid consequential damage, follow the procedure below exactly in the order described.

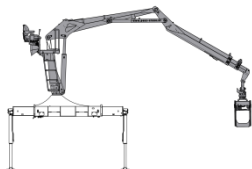

Bring the load arm into the position illustrated.

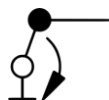
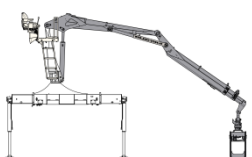

Place the grab securely on the ground.

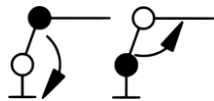
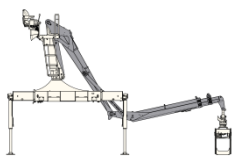

At the same time, lower the lifting arm and tilt the articulated arm to drive over the dead point of the articulated joint. The grab must remain on the ground.



Raise the articulated arm.

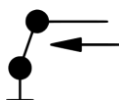

Retract the extension until the grab and load arm are fully engaged in the respective locking mechanisms.

10. Accessories



Only those accessories may be used which are suitable for use on the respective loading crane. This especially affects the load handling equipment.



If incorrect or unauthorised load handling equipment is used, warranty claims cannot be made in the event of an accident or damage. Your PENZ service partners will gladly advise you.

10.1. Load handling equipment

The crane can be operated with different load handling equipment. Amongst other things, this includes:

- Wood grab
- Bulk material grab
- Orange peel grab
- Load lifting magnet



If your crane is declared as a wood loading crane in accordance with the EC Declaration of Conformity, the crane may only be used in conjunction with a wood grab to lift untreated wood. The use of other load handling equipment requires additional safety equipment, such as load-maintaining valves.

With collapsible cranes make sure that the grab on the load arm is properly locked in the transport position. PENZ load handling equipment is optimally designed for PENZ cranes.

10.2. High level/high seat

Only enter and exit the high level/high seat via the equipment provided to do so.



Harmless climbing and exit of the operator's platform must be possible via the climbing aid as per assembly guidelines.



When climbing and leaving the operator's platform, make sure you don't activate any operating elements.



Do not get up from high seat during crane operation. This can lead to the operator falling.



If the high seat is used for work or repairs to the crane above the vehicle cab, there is a crushing risk. The high level/high seat may only be used for working in the loading area. Maintain the safety distances (see 7.2.3 Personal protection and the protection of bystanders).

10.3. p+ System

The p+ System is used in systems with pressure boosting (extra equipment) to temporarily increase the lifting force by up to 20%. The working speed is reduced to 10%.



The p+ System is not designed for continuous operation. The increased heat dissipation during continuous operation leads to an overheating of the hydraulic oil and a shortening of the life time.

Switching to p+ operation takes place by pressing the corresponding button on the right switch housing.



Switching from p+ operation to normal operation should take place without any load, because the lifting arm may drop otherwise.

10.4. Electrically heated seat covers



Electrically heated seat covers must be removed after each use of the crane seat and stored properly to protect against weather effects.

11. Service and maintenance

The reliability, operating safety and lifetime of your PENZ crane are particularly dependant on the regular and proper performance of maintenance and service. All of the following information is therefore not a recommendation but must be complied with by the device operator.

Before carrying out maintenance or repairs, you must note the following points:

- Use adequate and functional tools.
- Inspect the crane for worn parts and replace them before they can cause disruptions or damage.
- Always remember that safety is always first priority when carrying out work!
- Ensure cleanliness while working.
- Ensure that all hydraulic circuits of the crane are depressurised!
- Also make sure that the crane is de-energised.



Maintenance work may only be carried out when the machine is at a standstill. Keep steps, standing surfaces and handrails clean!



Service and maintenance work must be carried out in accordance with the specifications of the "Service and Maintenance Guidelines"!



The "Service and Maintenance book" must be carried on every crane and all work must be documented!



You can find further information in the "Service and maintenance guidelines" document.



The current "Service and maintenance guidelines" are available to download from the home page!

Menu -> Downloads -> General Information

12. Warranty

Unless otherwise agreed, the statutory warranty provisions valid at the time of conclusion of the contract shall apply.

Please note that warranty claims can only be asserted if maintenance and service work has been carried out in accordance with our regulations. After 20 operating hours or at the latest two months after handover, the crane must be taken to a PENZ workshop or our in-house service department for servicing.



Warranty claims can only be made for original PENZ spare parts.



Repairs may only be carried out by authorised workshops.



You can find further information in the "Service and maintenance guidelines" document.



The current "Service and maintenance guidelines" are available to download from the home page!

Menu -> Downloads -> General Information



The warranty application is available for download on the home page!

Menu -> Downloads -> General Information

13. Contact information



Contact	
General	
Opening times:	Mon - Fri: 6:00 am – 6:00 pm
Tel.:	+43 (0) 3577-76000
Fax:	+43 (0) 3577-76000-30
E-mail:	office@penz-crane.at
Home page:	www.penz-crane.at
Internal sales	
Tel.:	+43 (0) 3577-76000-31
E-mail:	sales@penz-crane.at
Customer service	
Mobile:	+43 (0) 664-82-11-298
Tel.:	+43 (0) 3577-76000-32
E-mail:	aftersales@penz-crane.at
Repairs	
Mobile:	+43 (0) 664-82-11-297
E-mail:	reparatur@penz-crane.at
Service	
Tel.:	+43 (0) 3577-76000-18
E-mail:	service@penz-crane.at



The contact details of the field staff and authorised workshops can be found on the home page!

Menu -> Sales & Service