

6ZR 7Zp+R



52 - 64 kNm



7,0 - 8,6 m



2,66 - 2,75 m



3,3 - 4,1 m



1.270 - 1.350 kg



410°



14 kNm



205 - 240 bar



Minimum 60 l/min ~ 30 kW



Minimum 90 l/min ~ 35 kW

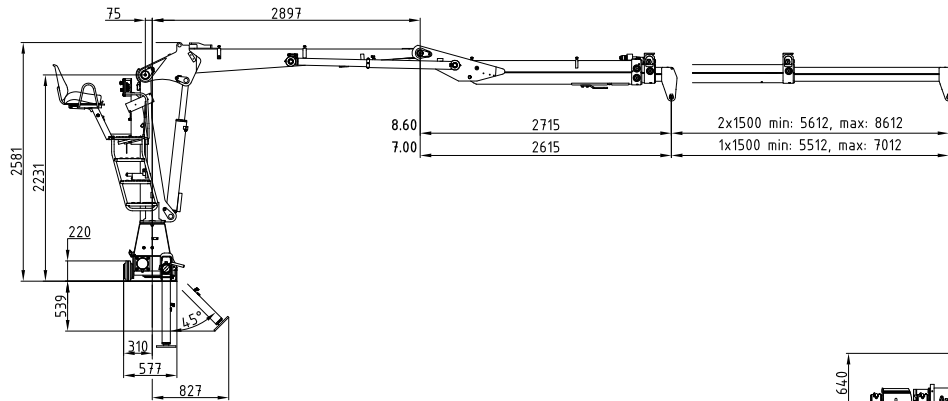

Kransockel Standard
Crane base standard

Kransockel mittig
Crane base centered

Kransockel stationär
Crane base stationary

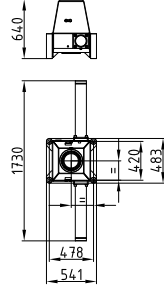
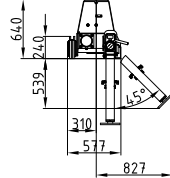
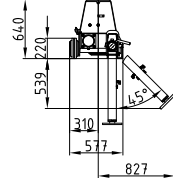

Kransockel Standard
Crane base standard

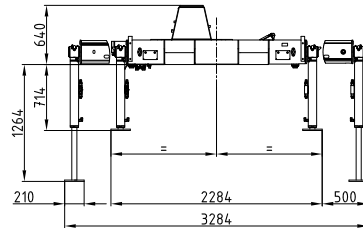

Kransockel mittig
Crane base centered

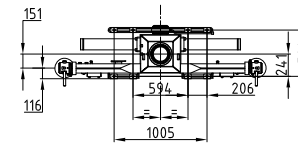
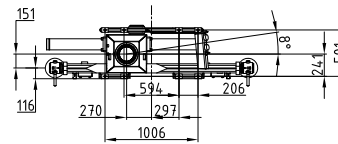
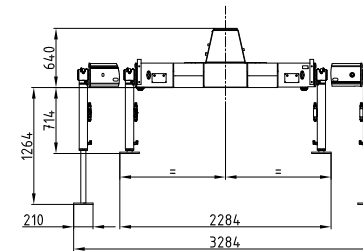

8.60

7.00

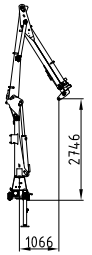
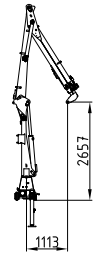

Klappabstützung
Folding support

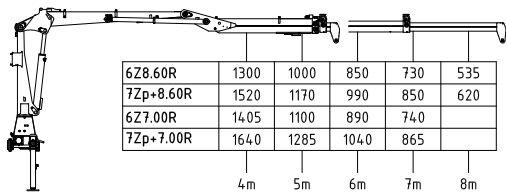
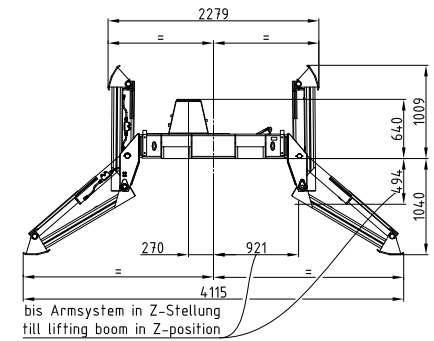

6Z8.60R	1300	1000	850	730	535	[kg]
7Zp+8.60R	1520	1170	990	850	620	[kg]
6Z7.00R	1405	1100	890	740		[kg]
7Zp+7.00R	1640	1285	1040	865		[kg]

Rücksitz 01
Back seat 01

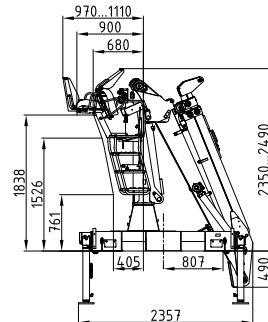

Rücksitz 04
Back seat 04

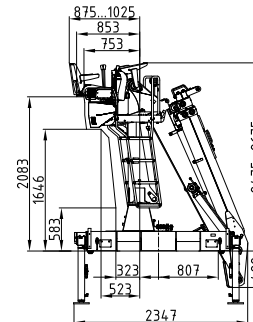

Seitensitz 04
Side seat 04

